



Article citation info:

Novaković B, Radovanović Lj, Zuber N, Radosav Đ, Đorđević L, Kavalić M. Analysis of the influence of hydraulic fluid quality on external gear pump performance. *Eksploracja i Niezawodność – Maintenance and Reliability* 2022; 24 (2): 260–268, <http://doi.org/10.17531/ein.2022.2.7>.

Analysis of the influence of hydraulic fluid quality on external gear pump performance

Indexed by:



Borivoj Novaković^{a,*}, Ljiljana Radovanović^a, Ninoslav Zuber^b, Dragica Radosav^a, Luka Đorđević^a, Mila Kavalić^b

^aUniversity of Novi Sad, Technical Faculty “Mihajlo Pupin”, Djure Djakovica bb, 23000 Zrenjanin, Serbia

^bUniversity of Novi Sad, Faculty of Technical Sciences, Trg Dositeja Obradovica 6, 21000 Novi Sad, Serbia

Highlights

- Analysis of the efficiency of the external gear pump by monitoring the parameters.
- Measurements at maximum pump pressures showed a drastic drop in its flow.
- Testing and analysis of hydraulic working fluid.
- Filtration of hydraulic oil and repair of damaged gaps increase the pump's efficiency.

Abstract

The basis of every hydraulic system is based on energy transformations, which are realized through hydraulic working fluid. Hydraulic oils are certainly subject to changes within their structure, meaning the basic characteristics and parameters of hydraulic oil, such as density, viscosity, humidity. The oils that are exploited are exposed to the process of degradation, which largely leads to significantly poorer quality of hydraulic fluid. The paper deals with the influence of changes in the characteristics of the hydraulic fluid on the hydraulic operating parameters of the gear pump installed on the hydraulic press. The parameters refer to pressure, flow, and temperature, as well as the quality of hydraulic oil, which affects the volumetric efficiency of the pump, and the results presented in the conclusion are based on the measured values of parameters before and after corrective measures. The control of parameters aims to increase the efficiency and reliability of the hydraulic system, a way of modern detection of deviations of parameters from standard, required values.

Keywords

This is an open access article under the CC BY license (<https://creativecommons.org/licenses/by/4.0/>)

hydraulic system, press, fluid, oil, degradation, filtration, external gear pump, measurement, efficiency.

1. Introduction

Condition Based Maintenance compared with other maintenance strategies is considered a more efficient way to reduce maintenance costs. The diagnostic itself consists of detection, isolation, and identification of failures, whereas prognostic is a prediction activity before the failure occurs. In line with modern trends in industrial production, it is interested in keeping the system fully functional during its service life, and Savić et al. [10] defined the reliability of individual elements of the hydraulic system and presented the behavior of the reliability curve on the example of a gear pump. The policy of this concept implies the introduction of new trends in maintenance strategy that lead to the prediction of failure and decision-making when a system is subject to preventive or corrective maintenance and when inspections [3, 35]. According to [18], the basic function of organizing system maintenance is:

- diagnosing the causes of technical system failure,
- troubleshooting.

Rotary equipment, which certainly includes hydraulic elements hydraulic pumps, in this case, the external gear pump, require extremely

high performance [41]. Working fluids greatly influence the reliability and efficiency of hydraulic pumps, i.e., hydraulic oils and their quality during operation. High pressures and dynamic loads affect the structure of the fluid, which can further lead to degradation and loss of performance of the fluid itself, which causes damage to internal components. When it comes to the performance and efficiency of the gear pump, Negrov et al. [17] claim that the most common reason for the impact on efficiency and performance is actually the geometry inside the pump, i.e., all the elements that create the appropriate tightness, taking into account the standard bearings of moving, rotating elements.

Hydraulic systems are one of the most complex industrial systems. Systems of this type are characterized by high precision operation during energy transformations within the system. They aim to increase the transmitted power, minimize environmental pollution, increase the technical life and reliability of the machine [7]. As stated by Han and Jiang [5], diagnosis and condition monitoring are crucial for improving the reliability and stability of hydraulic pumps. Energy transformations are realized through hydraulic working fluid, i.e., hydraulic oil, and it is necessary that such systems are in the standard

(*) Corresponding author.

E-mail addresses: B. Novaković (ORCID: 0000-0003-2816-3584): borivoj.novakovic@tfzr.rs, Lj. Radovanović (ORCID: 000-0002-5234-4820): ljiljana.radovanovic@tfzr.rs, N. Zuber (ORCID: 0000-0003-0843-2732): zuber@uns.ac.rs, D. Radosav (ORCID: 0000-0002-0540-6910): aronradosav@gmail.com, L. Đorđević (ORCID: 0000-0003-4578-9060): luka.djorjdevic@tfzr.rs, M. Kavalić (ORCID: 0000-0001-7053-2334): milazakin@gmail.com

and required quality. Fluids require monitoring of parameter quality, so the final state is determined based on their parameters [32]. Oil purity is one of the most important characteristics of any hydraulic system [15].

The characteristics of hydraulic oil according to which the quality of oil can be concluded are certainly:

- density,
- viscosity,
- humidity.

According to [25], density and viscosity are the main parameters that affect the pressure losses within a hydraulic system and thus increase the system's inefficiency, and therefore question the reliability of the system and its operation.

When it comes to hydraulic presses, the focus of the problem is on the drive elements, pumps, valve controls, and the system's working fluid. In the case of diagnosing machines in operation, the causes of problems in the early stage of fault development can be detected, and their further growth monitored, reducing its development, and thus reducing the number of unwanted downtimes of the monitored system and total costs. Modern diagnostic methods also require specific equipment that accompanies these methods. In testing the functionality and reliability of the mentioned elements, devices for testing the flow, pressure, and temperature of a hydraulic system, i.e., a hydraulic turbine with CAN software, were used in this paper. The hydraulic fluid analysis is performed through a laser device for reading the presence of solid particles inside the fluid and a viscometer for reading the kinematic viscosity of the working fluid. The service life and the quality of the oil depend to a large extent on the way the hydraulic systems are operated, and if the system is designed, maintained, and adjusted properly, one of the main causes of failure is a degradation of working elements or physicochemical characteristics of hydraulic fluid. To determine the quality of hydraulic oil, several aspects analyzed in papers are certainly important [37, 38], where the main causes of oil contamination are metallic and non-metallic particles, air bubbles.

Condition monitoring can be performed online and offline, depending on sampling capabilities, system structure, and conditions [27]. In this paper, a combination of the laser-optical method of hydraulic fluid quality analysis is presented, and in addition to the mentioned method, there are several other standardized methods for oil testing, such as Rodrigues et al. [22] described in their paper.

In addition to physicochemical indicators of oil quality, there are also operational indicators, which show anti-wear and oxidation life [14]. In practical application, the most commonly used oils are viscous grades ISO VG 46 and ISO VG 32, and according to the ISO standard of quality class HM or HV.

Based on the analysis of the state of the hydraulic fluid within the hydraulic system, a prediction of the system's state and potential component failures can be made. Constant monitoring of characteristics contributes to reducing the risk of unnecessary machine downtime, which would cause greater economic losses. The process of working fluid filtration is a way and solution for extending the life of the effective duration of the fluid and its function prescribed by petrochemical standards. When it comes to hydraulic systems, 70% of the causes of component failures, whether in the initial phase or in the advanced phase, are caused by the working fluid circulating in the system. Detection and identification of the operation of the system's hydraulic components are performed using a test of parameters, artificial simulation of the increase in pressure in the system, and the behavior of flow and temperature. The reliability and correctness of the hydraulic pump, as a drive unit, is described in papers [8, 35] as crucial in terms of the correctness of the supporting elements of the system, considering the potential occurrence of cavitation within the system due to pump suction problems, hydraulic shocks, that would greatly negatively affect other components of the system, causing potential damage and increased leaks as well as much shorter service life. By evaluating all tested elements of the system, it increases the

percentage accuracy of predicting the reliability of work and facilitates the assessment of the remaining service life. In order for testing to be valid and technically correct, experience and detailed knowledge of the behavior of a given system is necessary because in addition to testing a gear pump, other system segments, valves, manifolds, and actuators, such as cylinders, must be considered. Given that the hydraulic press system is very complex, with several modes of operation and load, it is important that data collection is performed by segments, from initial units to end components, taking into account that the system is closed and that the behavior within the system cannot be seen or concluded without a detailed analysis of each component of the system. Torrent et al. [33], described in their paper the definition of volumetric efficiency through pump torque. The importance of this type of diagnostics is reflected in the precise assessment of the state of the system, and especially the working fluid as an energy carrier, and not based on sampling, testing can be performed further prediction of behavior, based on working conditions and parameters. When it comes to predictive maintenance of hydraulic gear pumps, it can be performed by other types of diagnostics, e.g., implementation of vibrodiagnostics. This type of diagnostics can detect the problem from the aspect of bearing failures on the pumps, as well as the wear of the gears inside the pump rotor, which allows easier access to the identification of potential failures without unnecessary downtime.

In the segment of parameter testing methodology, the steps of the approach to testing the hydraulic system of the press are described.

2. Methodology for testing hydraulic press parameters

The testing methodology in this paper refers to two segments of testing:

- testing of hydraulic fluid parameters,
- testing the pressure, temperature, and flow parameters of the drive element of the press system - gear pump with external gearing.

2.1. Dependence of viscosity and density of hydraulic fluid ISO HM VG 46 on temperature and pressure

As the main characteristic of hydraulic oil, viscosity has very important functions within a system, such as lubrication and sealing (avoiding fluid leakage from pump chambers, valves, motors). The viscosity must have precisely defined limits, taking into account the system's requirements, especially due to the uniform flow, which directly affects the efficiency of work [30]. For each system and condition, it is necessary to determine the minimum allowable limits of oil viscosity in order for the system to be well exploited and thus to avoid the degradation process. In their paper [8], Hruzik et al. proved that the temperature differences of hydraulic oil directly affect the change in oil viscosity, and thus the change in pressure within the system, which further represents a causal link with the system's reliability. An increase in viscosity leads to increased friction and elevated temperature, which directly causes oxidation of the lubricant. A drop in viscosity below the allowable limit affects the lubrication process itself, reduces the layer of lubricant film, and directly affects the increased wear within the system [12]. From the aspect of the working fluid, the authors dealt with the examination of its parameters in the hydraulic press system, in several operating modes, and with one type of working fluid, i.e., industrial oils, in order to get a clear picture of the behavior of fluids within the system. The laser method is used to measure the quality of the hydraulic fluid. Contaminants, pollutants in the liquid itself interrupt the light beam, throwing the image on the photodiode cell, where the change in light intensity directly affects the change in electrical output. The laser device in offline mode provides fast and accurate identification of fluid quality, displaying measured codes, sizes in microns in relation to set standards, as well as reading the relative humidity of the working fluid. Dynamic viscosity is

measured in rotary devices, and the kinematic viscosity is determined based on the density of the working fluid.

The determination of the dependence of viscosity, pressure, and temperature is represented by a mathematical model, shown in equation (1):

$$\eta(p, t) = \eta_a \exp \left\{ \frac{p}{a_1 + a_{2t} + (b_1 + b_{2t})p} \right\} \quad (1)$$

Dynamic viscosity can also be expressed in terms of pressure coefficient, modulated equation (2):

$$\bar{\eta}(p, t) = \eta_a \exp \{ \alpha p \} \quad (2)$$

and the coefficient can be expressed in terms of equation (3):

$$\alpha(p, t) = \frac{\ln \eta - \ln \eta_a}{p - p_a} = \frac{1}{a_1 + a_{2t} + (b_1 + b_{2t})p} \quad (3)$$

The dependence of temperature and viscosity is described according to Vogel's equation (4):

$$\eta(t) = K \exp \left\{ \frac{B}{t + C} \right\} \quad (4)$$

i.e., according to equation (5):

$$\eta(t) = K \exp \left\{ \frac{B}{t + C} \right\} \exp \left\{ \frac{p}{a_1 + a_{2t} + (b_1 + b_{2t})p} \right\} \quad (5)$$

Savić [25], defined the method of determining viscosity and density according to the following equations. The calculation of the kinematic viscosity as a function of pressure is shown in equation (6):

$$\rho(t) = \rho(t)_i \cdot (1 - \alpha_p \cdot \Delta T) \quad (6)$$

Measurement of oil density in the industry is performed using online systems or non-destructive measurement methods [2, 23]. Also, the required minimum limits and the behavior of the density of the working hydraulic fluid can be determined empirically by equations (7):

$$\rho(t) = \rho(t)_i \cdot (1 - \alpha_p \cdot \Delta T) \quad (7)$$

for the conditions of density change as a function of temperature change, and according to equation (8):

$$\rho(t) = \rho(t)_i \cdot \left(1 + \frac{\Delta p}{K_s} \right) \quad (8)$$

when using an adiabatic compression module.

Degradation is manifested in the form of an increase in micro particles within the fluid, which results in a decrease of fluid quality, i.e., a class that is not appropriate according to prescribed standards. Solid particles affect the appearance of specific wear mechanisms (abrasion, erosion, material fatigue, etc.) of contact surfaces of working elements [13, 36], as well as catalysis of chemical reactions in which compounds of high molecular weight are formed, which again in

combination with solid particles lead to the formation of deposits that disrupt the proper functioning of hydraulic components. According to [16], viscosity plays one of the most important roles in determining the volumetric efficiency of a pump. If the viscosity of the working hydraulic fluid is too low, there will be a decrease in volumetric efficiency and an increase in wear due to surface contact. Also, if a liquid with too high viscosity appears in the system, the potential for cavitation damage will appear [6] defines that the volumetric degree of utilization is a critical factor for determining the reliability of hydraulic systems. Performance improvement of the gear pump is achieved by properly designing the internal fluid dynamics of both side plates, and the gaps in the rotor must be determined micro-precisely to avoid losses [4]. Hydraulic oil diagnostics is based on an automated system for monitoring the rate of change of intensity and the degree of fluid degradation over time [24, 34].

2.2. Pressure-temperature-flow characteristics of the pump test

Hydraulic testing of gear pumps is based on the detailed isolation of all potential problems in one system from problems that can only be generated by pumps alone. The test is performed using a SCKIT-340-PTQ (Pressure-Temperature-Flow) turbine with a manually adjustable choke.

The technical characteristics of this device and the measuring range are:

- flow: $8 \div 300 \frac{l}{min}$,
- operating pressure: 350 bar ,
- accuracy: $\pm 1IR (IR - indicated reading)$,
- fluid temperature rate $-20^\circ C \div 90^\circ C$.

The application of this type of diagnostics covers all relevant tests related to the hydraulic condition of the pump, pressure, flow, and temperature. The gear pump is one of the basic units of the hydraulic system and control system. It is widely used in the field of mechanical engineering since the gear pump has the advantages of small size, light-weight, not sensitive to pollution, reliable operation, good performance, and its price is relatively low [26]. According to [28], the hydraulic gear pump requires proper design to allow control of oil flow, pressure, and temperature parameters and provide the correct diagnostic and prognostic parameters on that basis.

Testing of the hydraulic system component is performed in several steps to obtain the correct condition of the components. Each segment of the system is tested individually:

- Step 1: The test of the hydraulic system of the press starts from the test of the drive element, i.e., the gear pump. The measuring turbine is installed immediately behind the pump in the "by-pass" system, and the test is started. If the pump does not raise the pressure in the system at all, it is defective, however, if the pressure rises and the flow drops to a greater extent than allowed, then the volumetric efficiency of the pump is called into question.
- Step 2: If everything is in order with the pump, proceed to test the pressure relief valve. The turbine is installed on the P-line of the pump behind the pressure valve. By identifying the pressure, it can be concluded whether the problem is in the valve. If the pressure behaves normally in the system, the valve has no problems, and the test must be continued to the other components.
- Step 3: In this case, there is still the possibility of a diverter valve or a problem in the piston, which is excluded in this case because a problem with the pump is immediately identified.

The possibility of preventing the occurrence of a malfunction is reflected in the correct approach and interpretation of the pump wear diagnostics. A necessary precondition for such possibilities is knowledge of potential failures of this type of system [20]. In the case of gear pumps, axial and radial clearances occur due to tolerances in production, which leads to a decrease in the efficiency and proper

functioning of the pumps [19]. Figure 1 shows the external gear pump and all its components.

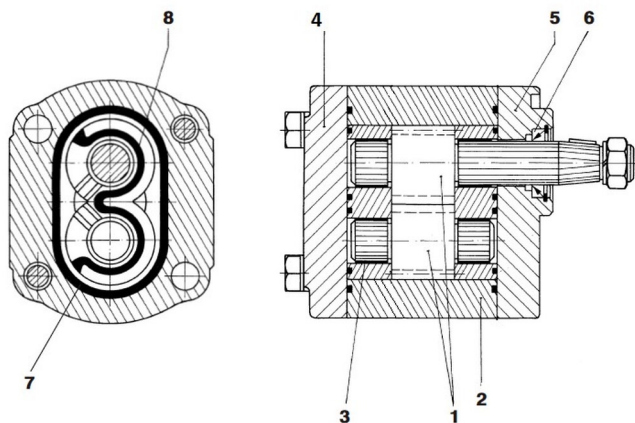

Fig. 1. External gear pump (1-couple of gears, 2-housing, 3-bearing, 4-rear cover, 5-front cover, 6-shaft seal, 7-seal to prevent external leakage, 8-axial clearance compensating seal)

What is necessary to know is that there must be precisely defined axial and radial gaps between the gears and the pump body so that the gears can move flexibly inside the pump, within a few microns [1, 21, 39], while radial the clearances between the pump housing and the sleeve for high-pressure pumps are from 0.015 mm to 0.025 mm of the shaft sleeve diameter. Zhao and Vacca [40], based their theoretical research on the flow of an external gear pump via the CFD model and cited clearances as a parameter that directly affects the pump efficiency. A common problem with gear pumps is the sealing elements, according to Figure 1, this refers to elements 7 and 8, which are 7-seal to prevent external leakage, 8-axial clearance compensating seal. The poor oil quality, elevated temperatures inside the impeller, and similar phenomena, which can cause internal wear of the pump elements, can damage the seals, resulting in a drop in pump performance.

3. Measuring the parameters of the hydraulic gear pump

3.1. PTQ test

The basic characteristics of pumps include flow, pressure, and temperature that occur in the system. It is generally known that hydraulic systems have standard defined operating temperatures within the system and that they are up to 60°C. The limit of 60°C applies to hydraulic oils type HM VG 46. When it comes to PTQ (Pressure-Temperature-Flow) characteristics, they are interdependent and based on their relationship, and pump functionality it can be defined by determining the actual volumetric efficiency. The measurement of the PTQ characteristics of the pump is performed using a turbine with a choke and CAN software for collecting data on the pump's behavior at different operating modes in test mode. The functionality and reliability of the pump and its volumetric efficiency are determined based on output data and a comparison of flow and pressure.

Characteristics of external gear pump

- displacement: 25 cm^3 ,
- flow: $34\frac{\text{l}}{\text{min}}$,
- max. pressure: 200bar,
- operating pressure: 120bar,
- speed: 1500rpm .

The Figure 2 shows a diagram of the PTQ dependence, where the pressure is brought to the maximum operating pressure in that system,

which in this case is 200 bar, and that pressure is held for an average of 1:20 to 1:40 minutes and 2:35 to 3:00 in an alternating mode.

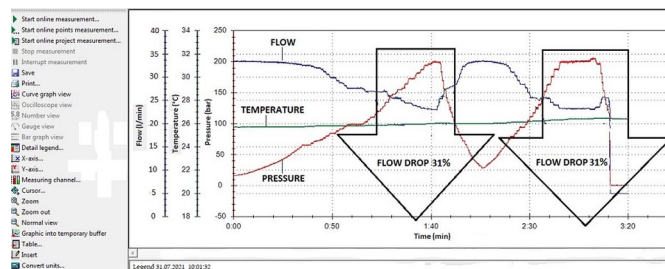

Fig. 2. PTQ characteristics of external high pressure gear pump

From the diagram (shown on Figure 2), a flow drop in the maximum operating pressure mode of 31% can be identified. Table 1 shows the measured flow values in relation to the pressure in the shown time range.

Table 1. Measured flow values according to pressure

Pressure (bar)	Flow (l/min)	Comment
10	33,546	
20	33,401	
30	33,389	
40	33,100	
50	32,960	
60	32,850	
70	32,823	
80	32,699	
90	30,089	
100	27,750	
120	27,543	Operating pressure
140	25,870	
160	24,968	
180	24,004	
200	23,570	Max. pressure

Based on the measured data, it was found that the tested gear pump has a problem in the interval of the maximum operating pressure of 200 bar. Based on the measured values, it is concluded that the pump is inefficient in relation to its required characteristics. When it comes to operating pressure (120 bar), it refers to the pressure that most often occurs in the system, i.e. the maximum pressure required to perform one press cycle.

3.2. Quality testing of mineral hydraulic oil ISO HM VG 46

Measurements were made on a sample of oil that was in the hydraulic press at the time of testing. The type of oil is standard hydraulic mineral oil of viscous gradation 46. In its mode of operation, the hydraulic press has four temperature ranges that are achieved in the operation process, and according to this scope, fluid tests are performed.

At all temperature ranges, the change in the fluid's viscosity in relation to the achieved pressures in the system is measured, which automatically includes the density of the system's working fluid in the calculation. The viscosity calculation was performed at atmospheric pressure, at working pressure (120 bar), and at the maximum pressure achieved in the system (200 bar). The Parker IOS1210EUR type device is used in the oil analysis, which works on the principle of dimming and blocking light. Table 2 shows the results of the sampled oil.

Table 2. Measured values of hydraulic fluid

Description and sample identification	Working fluid-hydraulic oil			
	Measure units	Methods	Results obtained	Oil purity requirements according to standard ISO 4406-05
Oil purity	ISO cod	ISO 4406-05	22/21/19	19/17/14
Relative humidity RH	ISO cod	ISO 4406-05	87%	30-80%
Viscosity	mm ² /s	ISO 3104	37	46 (ISO HM VG 46)

In systems, in general, no working fluid is completely clean, i.e., it is not possible to produce a fluid without some percentage of contaminants, and it is necessary to determine the tolerance limits for the elements of hydraulic systems. When it comes to gear pumps, some ideal conditions are considered to be classification 19/17/14 according to the ISO 4406:2017 standard, while the humidity is between 30% and 80%.

Solid particles within fluids cause the biggest problems, as they are the most prevalent and harmful can cause physical damage, which automatically leads to a change in the pump's volumetric efficiency [29]. The most dangerous particles within the system are those particles that are smaller than the predicted clearances, particles up to 5 microns are very abrasive.

3.3. Identification of the cause of poor hydraulic parameters in the system

Based on the test, the measurement results obtained through the PTQ test do not match the concept of efficient operation of the hydraulic system of the press. In the first step of the measurement, a detailed approach to identifying the cause of the problem concluded that there are leaks inside the gear pump that do not belong to the classification of permissible, tolerant leaks according to the manufacturer's declaration. Based on such diagnostics, a visual inspection of all segments of the pump impeller is approached. Figure 3 shows the condition of the sealing elements for axial clearances and the seal to prevent leakage. Worn seals can be seen in the Figure 3 in several different places. The cause of the damage can be found in the poor quality of the hydraulic fluid, with a large percentage of coarse solid particles in the oil. Oil under pressure and the tendency of temperature rise to 60°C, and in some cases even more than the mentioned temperature, which largely causes the form of thermal deformation.

The seals on the test pump are made of nitrile rubber (NBR) material with the following properties:

- seal type: 70 NBR14.1,

- hardness: $70 \pm 5 ShA$,
- temperature range $-30 \div 100^\circ C$.

Nitrile rubber-type belongs to the seals of a lower class, especially from the aspect of resistance to higher temperature ranges and solid particles.

Based on the operating conditions of the gear pump on the hydraulic press, it is proposed to replace the material of the sealing elements with Viton-Kalrez material.

The properties of this sealing material are as follows:

- seal type: 80 FKM10.1,
- hardness: $80 \pm 5 ShA$,
- temperature range: $-20 \div 200^\circ C$

Changing the material from NBR to FKM increases the resistance of the sealing element to the action of solid particles of metal origin and thus reduces the possibility of damage to the surface of the sealing element. Also, Viton material has the characteristic of higher resistance to heating and temperature rise inside the pump, which in this case occurs to temperature ranges of approximately 100°C.

3.4. Working fluid filtration process

Based on the measured and analyzed values of the hydraulic working fluid, oil class HM VG 46, it is necessary to filter the oil in the system. The filtration process restores the quality and technical performance of the working fluid to an appropriate extent, which is specified by the working fluid quality standards for a precisely defined pump [11].

In order to bring the system to a proper working condition, the hydraulic fluid was filtered before commissioning, and the filtration results are shown in the Table 3.

After the process of filtration of the hydraulic working fluid, the data on the working fluid parameters are shown in Table 3. After the filtration process, the percentage of moisture inside the oil is reduced, thus achieving a higher viscosity of the working fluid. In addition to

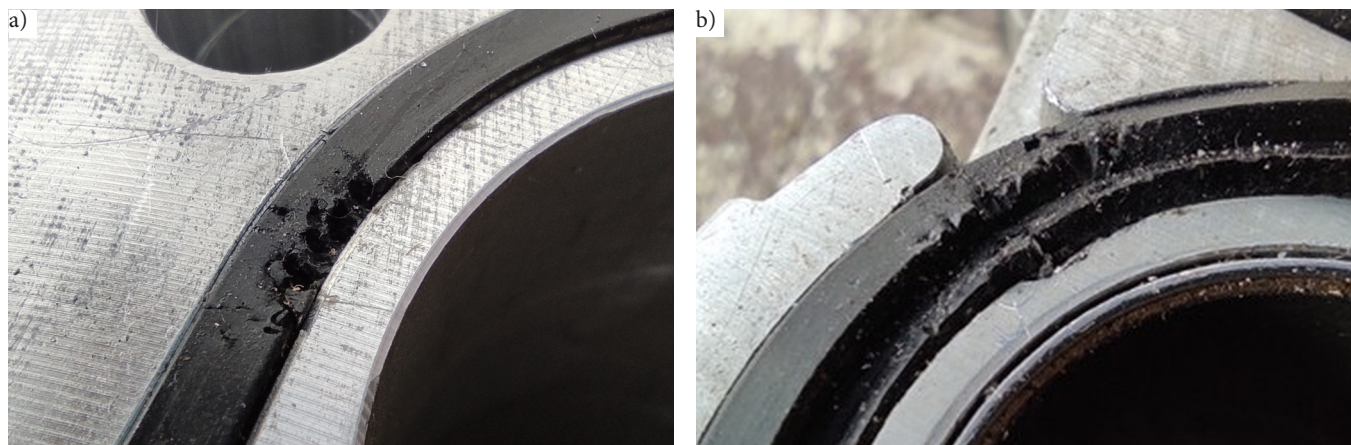

Fig. 3. Identified places of damage to the sealing elements: (a) damage to the sealing ring at the point of prevention of external leakage; (b) damage to the surface of the sealing element to prevent external leakage

the mentioned process, the process of filtering solid particles within the working fluid was performed and based on the measured particles by the laser method, the oil is classified in class 20/17/14, which is certainly within the permissible limits and standards for gear pumps.

Table 3. Measured values of hydraulic fluid after filtration process

Description and sample identification	Working fluid-hydraulic oil			
	Measure units	Methods	Results obtained	Oil purity requirements according to standard ISO 4406-05
Oil purity	ISO cod	ISO 4406-05	20/17/14	19/17/14
Relative humidity RH	ISO cod	ISO 4406-05	34%	30-80%
Viscosity	mm ² /s	ISO 3104	43	46 (ISO HM VG 46)

4. Results and discussion

Based on the measured values of the working fluid and the basic parameters of the hydraulic press, the drive element of which is a hydraulic external gear pump, an image of the behavior of the system operating under inadequate operating conditions was created. After the steps taken, it is necessary to analyze the obtained results, both from the aspect of the parameters of the hydraulic working fluid and from the aspect of the parameters of pressure, temperature, and flow. The kinematic viscosity analysis was performed in four temperature ranges 20°C, 26°C, 40°C, 60°C. Figure 4 shows the kinematic viscosity of the working fluid ISO HM VG 46.

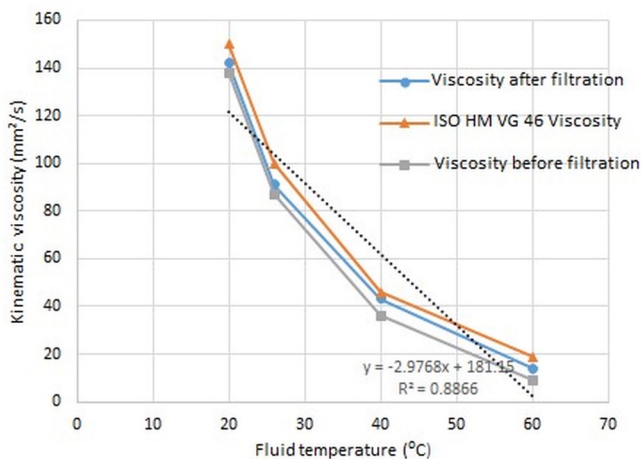

Fig. 4. Viscosities of the working fluid at atmospheric pressure

Considering that the hydraulic system is in operation and testing in two more cases, the first when the operating pressure, i.e., 120 bar and when the system is subjected to maximum pressure, which in this case for a given pump is 200 bar, the behavior of kinematic viscosity was analyzed and under those conditions. Figure 5 shows the analysis of kinematic viscosity at operating pressure in a 120 bar system.

According to Figure 5 it can be determined that at the operating pressure achieved by the pump, there is a drastic difference in the viscosity of the fluid, especially at the maximum tested temperature of 60°C, while at the optimal operating temperature of 26°C differences in viscosity occur. Figure 6 shows the projection of fluid viscosity at a maximum system pressure of 200 bar.

The exponential decrease in the kinematic viscosity of the fluid directly depends on the increase in temperature inside the system, and in the case of increasing pressure to 200 bar, as in the case of maximum pump load, the viscosity decreases dramatically when the fluid is unfiltered relative to the filtered fluid and ideal condition according

to ISO standard for oil type HM VG 46. Figure 7 shows the analysis of the working fluid density.

The density of the working fluid depends on the temperature and pressure conditions prevailing in the system. It is a well-known fact that oil becomes thicker during longer working life, and loses its tribological properties. Controlling the behavior of the working fluid density is important from the aspect of the technical quality of the working fluid and its actual function. Figure 7 shows the standard values that need to be set as the limit conditions for the behavior of the working fluid density at appropriate pressures and temperatures.

After the process of filtering and projecting the behavior of the working fluid under different conditions within the hydraulic system, and performed corrective measures for the implementation of new material of the sealing elements of the gear pump, the PTQ characteristics of the system were measured. Figure 8 shows the results of the gear pump parameters under the new operating conditions.

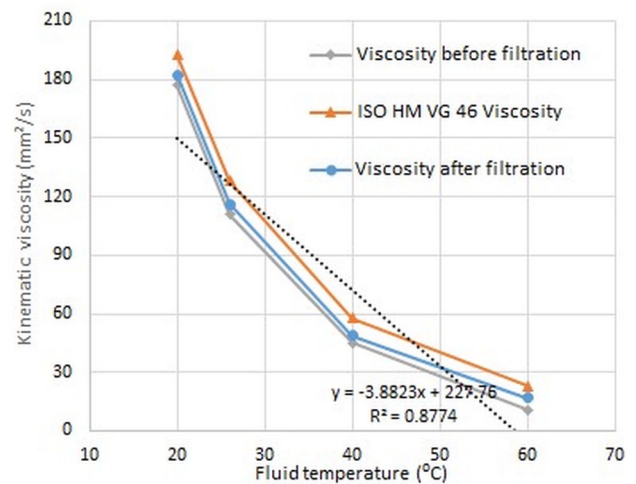

Fig. 5. Viscosities of the working fluid at an operating pressure of 120 bar

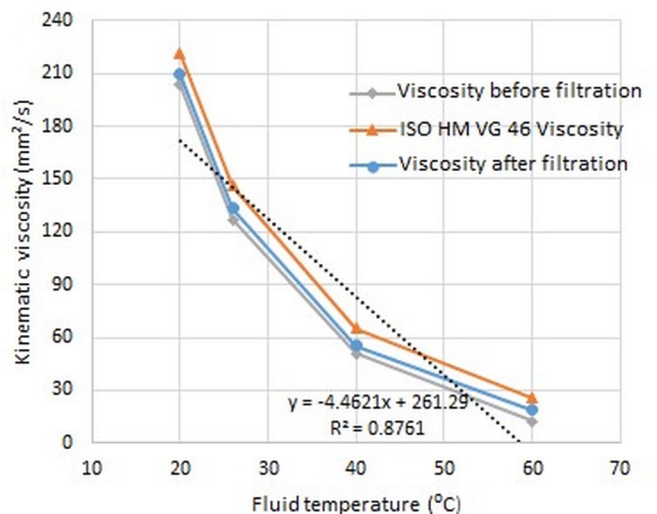

Fig. 6. Viscosities of the working fluid at a maximum pressure of 200 bar

The measured parameters on the gear pump are now within the permissible limits. The measured flow drop at the highest pressure that the pump can achieve is 7%, which is the efficient operation of the pump. The pump was tested twice at similar time intervals to con-

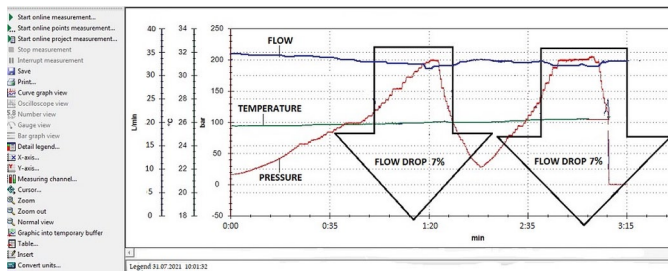

Fig. 8. PTQ parameters of gear pump operation after implementation of new solution

Table 4. Measured flow values at certain pressures after the implementation of the new solution

Pressure (bar)	Flow (l/min)	Comment
10	33,998	
20	33,996	
30	33,993	
40	33,991	
50	33,896	
60	33,898	
70	33,805	
80	33,745	
90	33,604	
100	33,551	
120	33,001	Operating pressure
140	32,895	
160	32,303	
180	31,905	
200	31,621	Max. pressure

firm the result. As in the first case, the load-interval of the pump at the highest pressure is approximately the same. The temperature of the fluid has a slight tendency to increase, since on this system of hydraulic presses, in some time intervals it is over 60°C.

Table 4 gives the exact flow values at the corresponding pressures. Table 5 shows the results of volumetric degrees of gear pump efficiency in two cases in relation to the minimum allowable limits of theoretical volumetric efficiency. Figure 9a shows the ratio of pressure and flow before and after corrective measures, as well as the ratio of volumetric efficiency of the gear pump before and after the implementation of the new solution (Figure 9b).

After applying an adequate solution, one can see an obvious difference between the degree of efficiency, since in the first case, the degree of efficiency is below the theoretical criteria provided for that pump and those modes of operation of the pump (Figure 9b). In the second case, which is defined after corrective measures, it is concluded that the volumetric efficiency in the mode of maximum working pressure this time has a good percentage since the efficiency ranges from 0,92-0,98 for entirely correct pumps.

The minimum theoretical criterion of volumetric efficiency for a maximum working pressure of 200 bar is 0,853.

Szewim [31], described the influence of radial and axial clearances on the volumetric efficiency of a gear pump and the application of CFD models for dynamic flow analysis in the meshing zone and suction chamber. Considering that on the example of this gear pump, the gear fits according to standards and tolerances, the volumetric efficiency is determined based on leaks on the sealing elements of the pump chamber.

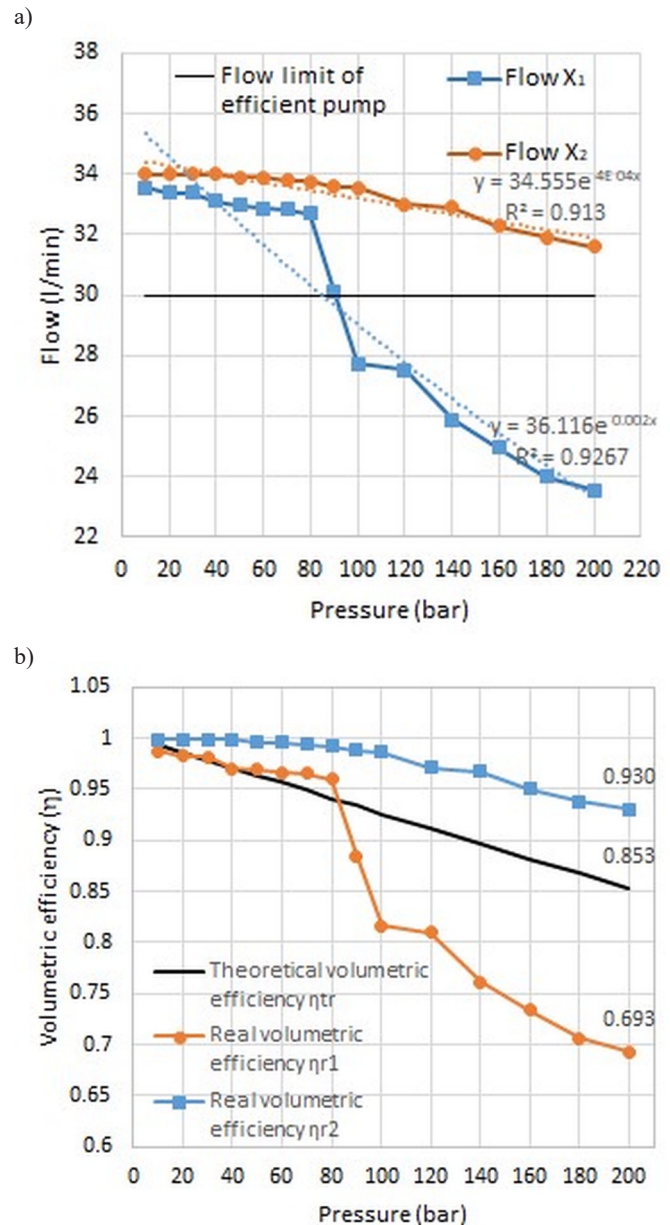

Fig. 9. Comparative analysis of: (a) gear pump flow before and after the implementation of a new solution; (b) volumetric efficiency of gear pump in the case before and after implementation of new solution

5. Conclusions

Hydraulic systems and their components require clearly defined operating conditions, and the reason for this is the sensitivity of the components to any changes in conditions within the system. High-pressure gear pumps must be geometrical of ideal design in order to achieve the required pump flow functions. As an executive element of the hydraulic system, the gear pump's reliability and efficiency directly affect the reliability and efficiency of the whole system. A large percentage of failures of hydraulic components are caused by hydraulic working fluids, which degrade over time and with partially unsuitable operating conditions, and their quality does not correspond to standard oil classes. The importance of the paper is reflected in the examination of the characteristics from the aspect of pressure, temperature, and flow, on the one hand, while on the other hand, the examination of the behavior of the hydraulic working fluid, before and after the filtration process. By designing the behavior of the working fluid within the system, data are obtained on the necessary conditions for efficient operation of the pump, as well as for the required structure of the pump, in this case, the sealing elements. Based on the obtained

Table 5. Volumetric efficiency of external gear pump

Pressure (bar)	η_{r1}	η_{lr}	η_{r2}
10	0,987	0,993	0,999
20	0,983	0,985	0,999
30	0,982	0,979	0,999
40	0,970	0,971	0,999
50	0,969	0,963	0,996
60	0,966	0,957	0,996
70	0,965	0,949	0,994
80	0,960	0,941	0,992
90	0,885	0,934	0,988
100	0,816	0,926	0,986
120	0,810	0,912	0,971
140	0,761	0,897	0,967
160	0,734	0,882	0,950
180	0,706	0,868	0,938
200	0,693	0,853	0,930

values of the sampled oil and the oil that has passed the filtration process, the projection of the behavior of that oil under different conditions, which is dictated by the system, is performed. Precisely defined

tolerances define the geometrical characteristics inside the pump so that fluid flow inside the working chamber is ideal. The appearance of solid particles inside the working fluid and the decrease in viscosity directly affect the quality of lubrication of the impeller, as well as the appearance of abrasive wear, which occurs when solid particles under pressure come into contact with the pump body surface, in this case with sealing elements and leave negative effects on them.

The effect of such a phenomenon is reflected in the system's poor performance, the direct impact on the parameter values of pressure, temperature, and flow, and thus on the overall volumetric degree of efficiency of the gear pump. Stabilizing the flow drop, or reducing it to the allowable limits, is a priority if the system tends to work efficiently. In this paper, by filtering hydraulic oil and restoring its quality to appropriate satisfactory limits, and by replacing materials with suitable sealing elements, the flow drop is reduced from 31% to 7% at a maximum pressure of 200 bar, which corresponds to the gear efficiency standard ($\eta=0.93$). Compared with optimal working conditions, i.e., with an operating pressure of 120 bar, the operating efficiency has been brought to a measure of $\eta=0.971$, which can already be considered the ideal condition of the pump. By optimizing the system's operation, which is achieved, among other things, by periodically monitoring the state of the components, potential downtime is avoided as a result of reduced efficiency, and thus overall reliability, which in this case is reflected through efficiency.

References

1. Abdallah El-Hadj A, Abd Rahim S Z B. Optimization of an External Gear Pump using Response Surface Method. *Journal of Mechanics* 2020; 36(4): 567–575, <https://doi.org/10.1017/jmech.2020.7>.
2. Chakhlov V L, Cheprasov A I, Shaverin N V. Measurements of the density of petroleum products and their mixtures by the ultrasonic method. *Russian Journal of Nondestructive Testing* 2002; 38(6): 472–476, <https://doi.org/10.1023/A:1022187228570>.
3. Do P, Voisin A, Levrat E, Iung B. A proactive condition-based maintenance strategy with both perfect and imperfect maintenance actions. *Reliability Engineering & System Safety* 2015; 133: 22–32, <https://doi.org/10.1016/j.res.2014.08.011>.
4. Frosina E, Senatore A, Rigosi M. Study of a High-Pressure External Gear Pump with a Computational Fluid Dynamic Modeling Approach. *Energies* 2017; 10(8): 1113, <https://doi.org/10.3390/en10081113>.
5. Han T, Jiang D. Fault diagnosis of multistage centrifugal pump unit using non-local means-based vibration signal denoising. *Eksploatacja i Niezawodność - Maintenance and Reliability* 2019; 21(4): 539–545, <https://doi.org/10.17531/ein.2019.4.1>.
6. Herzog S, Neveu C, Placek D. The benefits of maximum efficiency hydraulic fluids. *Machinery Lubrication* 2005; 7: 7–16.
7. Hoffmann D, Heřmánek P, Rybka A, Honzík I. Design a drive for interaxle mechanical cutter used in low trellises. *Agronomy Research* 2013; 11: 39–46.
8. Hružík L, Bureček A, Vašina M. Effect of Oil Viscosity on Pulsating Flow in Pipe. In Beran J, Bílek M, Žabka P (eds): *Advances in Mechanism Design II*, Cham, Springer International Publishing: 2017; 44: 137–143, https://doi.org/10.1007/978-3-319-44087-3_18.
9. Hu C-H, Lee M-Y, Tang J. Optimum step-stress accelerated degradation test for Wiener degradation process under constraints. *European Journal of Operational Research* 2015; 241(2): 412–421.
10. Jovanović M, Šević D, Karanović V et al. Increased Efficiency of Hydraulic Systems Through Reliability Theory and Monitoring of System Operating Parameters. *Strojniški vestnik – Journal of Mechanical Engineering* 2012; 58(4): 281–288, <https://doi.org/10.5545/sv-jme.2011.084>.
11. Jokinen A, Calonius O, Gorle J, Pietola M. Data correlation model for hydraulic fluid filter condition monitoring. *16th Scandinavian International Conference on Fluid Power (SICFP 2019)*; 2019: 212–220.
12. Karanović V V, Jovanović M T, Wakiru J M, Orošnjak M D. Benefits of lubricant oil analysis for maintenance decision support: a case study. *IOP Conference Series: Materials Science and Engineering* 2018; 393: 012013, <https://doi.org/10.1088/1757-899X/393/1/012013>.
13. Karanović V. Development of a solid particle influence model on performance of piston cylinder contacting pairs for hydraulic components. *Doctoral Dissertation*. University of Novi Sad; 2015.
14. Lu C, Li H, Zhang B et al. Research status of hydraulic oil evaluation technology. *Journal of Physics: Conference Series* 2021; 1983(1): 012035, <https://doi.org/10.1088/1742-6596/1983/1/012035>.
15. Majdan R, Tkáč Z, Abrahám R et al. Effect of Ecological Oils on the Quality of Materials of Hydraulic Pump Components. *Advanced Materials Research* 2013; 801: 1–6, <https://doi.org/10.4028/www.scientific.net/AMR.801.1>.
16. Michael P W, Khalid H, Wanke T. An Investigation of External Gear Pump Efficiency and Stribeck Values. 2012: 2012-01–2041, <https://doi.org/10.4271/2012-01-2041>.
17. Negrov D A, Burgunova O Yu, Pantyukhova K N et al. Influence of impurities on structure and reliability of gear pump. *AIP Conference Proceedings* 2018; 2007(1): 040010, <https://doi.org/10.1063/1.5051937>.
18. Otić G, Momčilović O, Radovanović L et al. Mathematical Analysis of Criteria for Maintenance of Technical Systems in the Function of Achieving Sustainability. *Sustainability* 2021; 13(4): 1680, <https://doi.org/10.3390/su13041680>.

19. Pietkiewicz P. Typical failures of gear pumps. Defects classification. UWM Olsztyn 2009; 12: 219–228, <https://doi.org/DOI 10.2478/v10022-009-0018-3>.
20. Ritucci A L, Frizziero L, Liverani A. Maintainability Approach: Hydraulic Pump with External Gears Explored with Design for Disassembly and Augmented Reality. *Applied Sciences* 2021; 11(2): 666, <https://doi.org/10.3390/app11020666>.
21. Rituraj F, Vacca A, Morselli M A. Modeling of manufacturing errors in external gear machines and experimental validation. *Mechanism and Machine Theory* 2019; 140: 457–478, <https://doi.org/10.1016/j.mechmachtheory.2019.06.016>.
22. Rodrigues J, Costa I, Farinha J T et al. Predicting motor oil condition using artificial neural networks and principal component analysis. *Eksploracja i Niezawodność - Maintenance and Reliability* 2020; 22(3): 440–448, <http://dx.doi.org/10.17531/ein.2020.3.6>.
23. Roshani G H, Roshani S, Nazemi E, Roshani S. Online measuring density of oil products in annular regime of gas-liquid two phase flows. *Measurement* 2018; 129: 296–301, <https://doi.org/10.1016/j.measurement.2018.07.026>.
24. Ruggiero A, Mindas M, Knapčíková L. Tribodiagnostic investigation on oil filtration: results from a novel apparatus. *Industrial Lubrication and Tribology* 2016; 68(6): 689–695, <https://doi.org/10.1108/ILT-03-2016-0053>.
25. Savić V, Knezević D, Lovreć D et al. Determination of pressure losses in hydraulic pipeline systems by considering temperature and pressure. *Strojniški vestnik-Journal of Mechanical Engineering* 2009; 55(4): 237–243.
26. Shen H, Li Z, Qi L, Qiao L. A method for gear fatigue life prediction considering the internal flow field of the gear pump. *Mechanical Systems and Signal Processing* 2018; 99: 921–929, <https://doi.org/10.1016/j.ymssp.2016.09.022>.
27. Shi H, Zhang H, Ma L, Zeng L. A multi-function sensor for online detection of contaminants in hydraulic oil. *Tribology International* 2019; 138: 196–203, <https://doi.org/10.1016/j.triboint.2019.05.025>.
28. Siano D, Panza M A. Diagnostic method by using vibration analysis for pump fault detection. *Energy Procedia* 2018; 148: 10–17, <https://doi.org/10.1016/j.egypro.2018.08.013>.
29. Singh M, Lathkar G S, Basu S K. Failure Prevention of Hydraulic System Based on Oil Contamination. *Journal of The Institution of Engineers (India): Series C* 2012; 93(3): 269–274, <https://doi.org/10.1007/s40032-012-0032-2>.
30. Sun Y, Wang P. Main Influencing Factors of Hydraulic Oil Performance for Construction Machinery. *IOP Conference Series: Materials Science and Engineering* 2019; 677: 022129, <https://doi.org/10.1088/1757-899X/677/2/022129>.
31. Szwemin P, Fiebig W. The Influence of Radial and Axial Gaps on Volumetric Efficiency of External Gear Pumps. *Energies* 2021; 14(15): 4468, <https://doi.org/10.3390/en14154468>.
32. Tkáč Z, Čorňák Š, Cviklovič V et al. Research of Biodegradable Fluid Impacts on Operation of Tractor Hydraulic System. *Acta Technologica Agriculturae* 2017; 20(2): 42–45, <https://doi.org/10.1515/ata-2017-0008>.
33. Torrent M, Gamez-Montero P J, Codina E. Parameterization, modeling, and validation in real conditions of an external gear pump. *Sustainability* 2021; 13(6): 3089, <https://doi.org/10.3390/su13063089>.
34. Vališ D, Žák L, Pokora O, Lánský P. Perspective analysis outcomes of selected tribodiagnostic data used as input for condition based maintenance. *Reliability Engineering & System Safety* 2016; 145: 231–242, <https://doi.org/10.1016/j.ress.2015.07.026>.
35. Van P D, Bérenguer C. Condition-Based Maintenance with Imperfect Preventive Repairs for a Deteriorating Production System: Condition-based maintenance with imperfect preventive repairs. *Quality and Reliability Engineering International* 2012; 28(6): 624–633, <https://doi.org/10.1002/qre.1431>.
36. Wooton D. The Lubricant's Nemesis-Oxidation. *Practicing oil analysis*; 2007: 5–6.
37. Wu T, Wu H, Du Y, Peng Z. Progress and trend of sensor technology for on-line oil monitoring. *Science China Technological Sciences* 2013; 56(12): 2914–2926, <https://doi.org/10.1007/s11431-013-5400-5>.
38. Zeng L, Yu Z, Zhang H et al. A high sensitive multi-parameter micro sensor for the detection of multi-contamination in hydraulic oil. *Sensors and Actuators A: Physical* 2018; 282: 197–205, <https://doi.org/10.1016/j.sna.2018.09.023>.
39. Zhang W G, Lin G M, Shang M, Chen Q. Analysis of External Gear Pump Failure. *Advanced Materials Research* 2013; 791–793: 623–626, <https://doi.org/10.4028/www.scientific.net/AMR.791-793.623>.
40. Zhao X, Vacca A. Numerical analysis of theoretical flow in external gear machines. *Mechanism and Machine Theory* 2017; 108: 41–56, <https://doi.org/10.1016/j.mechmachtheory.2016.10.010>.
41. Zuber N, Bajric R, Sostakov R. Gearbox faults identification using vibration signal analysis and artificial intelligence methods. *Eksploracja i Niezawodność - Maintenance and Reliability* 2014; 16(1): 61–65.