

Zbigniew KAMIŃSKI  
Paweł RADZAJEWSKI

## CALCULATIONS OF THE OPTIMAL DISTRIBUTION OF BRAKE FORCE IN AGRICULTURAL VEHICLES CATEGORIES R3 AND R4

### OBLICZENIA OPTYMALNEGO ROZDZIAŁU SIŁ HAMUJĄCYCH W PRZYCZEPACH ROLNICZYCH KATEGORII R3 I R4\*

*Fulfilling the requirements of the EU Directive 2015/68 in the area of braking for agricultural trailers depends on the proper selection of individual components of the braking system. This paper describes the requirements regarding braking performance and distribution of brake forces in agricultural trailers in R3 and R4 categories. On this basis, a methodology for calculating the optimal linear distribution of brake forces, characteristic for agricultural trailers with pneumatic braking systems, has been developed. The examples of calculation of an optimal distribution of brake forces for a two- and three-axle trailer with a tandem suspension system of the rear axle assembly have been provided. The optimization algorithm with the Monte Carlo method has been described, based on which a computer program was developed to select a linear distribution of brake forces in a three-axle trailer with 'walking beam' and 'bogie' suspensions. The presented calculations can be used in the design process to select the parameters of wheel braking mechanisms and then the characteristics of the pneumatic valves of the braking system.*

**Keywords:** brake force distribution, optimization, agricultural vehicles, braking systems.

*Spełnienie wymagań Dyrektywy UE 2015/68 w zakresie hamowania przyczep rolniczych zależy od właściwego doboru poszczególnych komponentów układu hamulcowego. W pracy opisano wymagania dotyczące skuteczności hamowania oraz rozdziału sił hamujących w przyczepach rolniczych kategorii R3 i R4. Na tej podstawie opracowano metodykę obliczeń optymalnego liniowego rozdziału sił hamujących, charakterystycznego dla przyczep rolniczych z pneumatycznymi układami hamulcowymi. Zamieszczono przykłady obliczeń optymalnego rozdziału sił hamujących dla przyczepy dwu i trzyosiowej z tandemowym układem zawieszenia zespołu osi tylnych. Opisano algorytm optymalizacji metodą Monte Carlo, na podstawie którego opracowano program komputerowy do doboru liniowego rozdziału sił hamujących w przyczepie trzyosiowej z zawieszeniem „walking beam” i „bogie”. Przedstawione obliczenia można wykorzystać w procesie projektowania do doboru parametrów kołowych mechanizmów hamulcowych, a następnie charakterystyk zaworów pneumatycznych układu hamulcowego.*

**Słowa kluczowe:** rozkład siły hamowania, optymalizacja, pojazdy rolnicze, układy hamulcowe

#### 1. Introduction

In trailers and towed agricultural machines, pneumatic or hydraulic braking systems powered and controlled from an agricultural tractor are used most often [4, 8, 17, 26, 27, 28]. At present, inertial overrun brakes can only be used in low-speed towed vehicles ( $v \leq 40$  km/h) with a total weight of less than 8000 kg and in high-speed vehicles ( $v > 40$  km/h) with a total weight not exceeding 3500 kg [2]. The service brakes of a tractor are driven by mechanical, hydraulic or air drive systems. The selection of drive system and energy source depends on the design and weight of the tractor.

Low and medium power tractors use simple and inexpensive hydraulic braking systems without power assistance [14]. Tractors with greater power use, first of all, hydraulic systems powered from the tractor hydraulic and pneumatic braking systems [17, 19, 27]. In low power tractors, mechanical brakes are still popular due to the costs.

The cooperation between tractor and trailer braking system is ensured by a trailer control valve (pneumatic or hydraulic) mounted in the tractor. Depending on the type of service brakes used in a tractor, the trailer control valves are mechanically, pneumatically or hydraulically actuated [12, 13, 22].

High-performance braking systems are a critical feature of modern agricultural vehicles. The new EU Regulation on Agricultural Ve-

hicles [2], which has been in effect since 2016, includes a number of novel and much higher requirements for the braking performance of tractors and trailers, compatibility, safety and stability standards, including the introduction of ABS for vehicles traveling at speeds above 60 km/h.

For all categories of towed vehicles, the required braking rate has been increased. For vehicles with a total weight of over 3500 kg (category R3 and R4 agricultural trailers and towed agricultural machinery of category S2) and moving at a speed of over 40 km/h, a requirement of a specific distribution of brake forces between the axles of a vehicle has been introduced. As a result, it is possible to meet the requirement of achieving a sufficiently large relative deceleration (braking rate, i.e. the quotient of vehicle deceleration and the gravity  $z=d/g$ ), conditioning the achievement of a short stopping distance and ensuring the directional stability of the braking vehicle in all traffic conditions. Similarly to the regulations concerning wheeled vehicles [24], no separate recommendations for vehicle combination were formulated, particular parts of tractor-trailer unit are treated as if they were single vehicles.

In order to adjust the distribution of braking forces between a tractor and a towed vehicle, compatibility requirements have been introduced for the first time in the form of permissible change areas

(\*) Tekst artykułu w polskiej wersji językowej dostępny w elektronicznym wydaniu kwartalnika na stronie [www.ein.org.pl](http://www.ein.org.pl)

for the braking rate of a towing vehicle and a towed vehicle in a pressure function in the control line. The compliance with compatibility requirements as well as requirements regarding high-speed operation (response time of less than 0.6 s [2]), contribute to the shortening of braking distance of tractor-trailer units and the reduction of forces in the coupling during emergency braking [21].

The adoption of the new European legislation in field of agricultural vehicle places high demands on manufacturers of agricultural trailers, tractors and machinery in terms of braking systems [5]. The total fulfillment of the requirements regarding efficiency, stability and compatibility of brakes for agricultural trailers depends on the correct selection and calculation of individual components of the braking system (brake mechanisms and actuators, valves, pipes and braking force correctors), taking into account the construction parameters of trailers including axle systems and the type of suspension used [1, 11, 16].

Engineering calculations of braking systems of agricultural trailers are divided into design (synthesis) and testing (analysis). The purpose of design calculations is to determine the basic design parameters of braking systems and their components, taking into account the given operational characteristics. Design calculations include, among others:

- determining the permissible distribution of brake forces,
- selection of characteristics of brake force correctors,
- calculation of forces and torques of braking of wheels on individual axes for a given distribution of brake forces,
- calculation or selection of brake mechanisms,
- selection of actuators and calculation of application device,
- choice of braking system concept and selection of its components (valves, pipes, etc.).

The verification calculations are aimed at building and analyzing the characteristics of a considered system when its construction parameters are known. Such verification calculations include, but are not limited to:

- calculation of braking efficiency at the prescribed minimum pressure in the braking system,
- calculation of static characteristics, including the adhesion utilized by axle in a pressure function in a brake cylinder (braking rate) and checking the course of tractor and trailer braking rates in a pressure function at the coupling head of control line (of compatibility bands of braking system),
- calculations of dynamic characteristics to check the speed of operation (time of reaction) and synchrony of operation of individual circuits in a braking system.

This paper describes the methodology for the optimal selection of distribution of brake forces in agricultural trailers in R3 and R4 categories. The calculations of the distribution of brake forces is the basis for design calculations of vehicle braking systems, as they have a significant impact on the selection of the basic mechanisms and components of a braking system and the braking system efficiency [23]. An example calculation of a linear distribution of brake forces in a two-axle trailer and a three-axle trailer with a tandem suspension system of the rear axle assembly is provided here. An algorithm for the optimization of a linear distribution of brake forces in a three-axle trailer using the classic Monte Carlo method is described here.

## 2. Requirements concerning the efficiency, stability and compatibility of the braking systems of vehicles in R3, R4 and S2 categories

In the process of the selection of braking forces distribution between the axles of a trailer (towed machine) it is necessary to aim of an ideal distribution. Then, the rates  $f_i$  of adhesion utilized by all axles are the same throughout the braking process and, therefore, equal to the braking rate  $z$  of the vehicle:

$$\frac{T_1}{R_1} = \frac{T_2}{R_2} = \dots = \frac{T_i}{R_i} = f_i = z \tag{1}$$

where:  $T_i$  - braking force of the wheels of the  $i$ -th axle,  $R_i$  - normal reactions of the road surface on the wheels  $i$ -th axle,  $z$  - braking rate of the vehicle  $z = \frac{\sum T_i}{\sum R_i}$

This distribution of brake forces is considered to be optimal because, with homogeneous surfaces, the achievement of the highest possible braking intensity in given conditions and the fulfillment of braking efficiency requirements with reserve are achieved (Table 1).

Table 1. The required braking efficiency of agricultural trailer's service brakes [2]

Vehicle category	Braking rate $z$ [%] in $p=6,5$ bar	
	$v \geq 30$ km/h	$v > 30$ km/h
Trailers R2, R3, R4	35%	50%
Towed machines S2	35%	50%

Due to the variable loading levels of trailers, it is practically impossible to achieve an ideal distribution of brake forces, even when using braking force regulators. Therefore, for high-speed agricultural vehicles (speed above 40 km/h), the allowable limits for derogation of adhesion utilization rates  $f_i$  for individual axles against the ideal distribution have been determined. From 2016, two solutions have been allowed, as shown in Figure 1 [2].

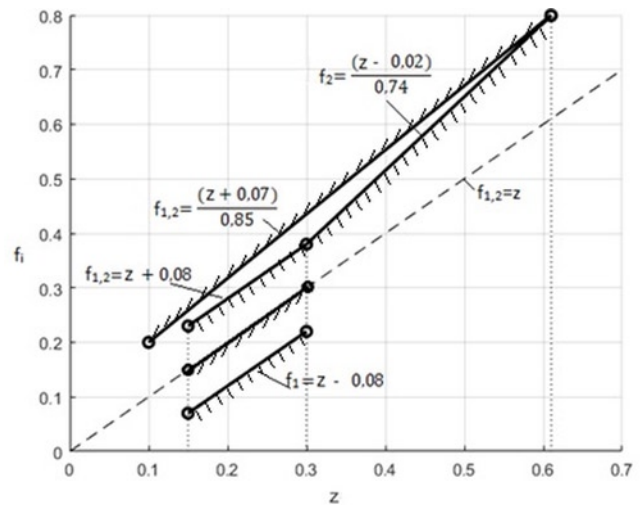

Fig.1. Limit values of adhesion utilization for both solutions

**The first solution:** the adhesion utilization rate for each axle must meet the condition of ensuring the minimum required braking performance:

$$\left. \begin{matrix} f_1 \\ f_2 \end{matrix} \right\} \leq \frac{z + 0.07}{0.85} \quad \text{for } z = 0.1 \div 0.61 \tag{2}$$

and the condition of previous locking of the front axle wheels to ensure directional stability:

$$f_1 > z > f_2 \quad \text{for } z = 0.15 \div 0.30 \tag{3}$$

**The second solution:** the adhesion utilization rates by the two axles should be within a given band, and then the limits of wheel locking are determined by the following relationships:

$$\begin{aligned} f_1 &\geq z - 0.08 \\ f_{1,2} &\leq z + 0.08 \end{aligned} \quad \text{for } z = 0.15 \div 0.30 \quad (4)$$

In addition, the adhesion utilization curve for the rear axle should fulfill the condition:

$$f_2 \leq \frac{z - 0.02}{0.74} \quad \text{for } z \geq 0.3 \quad (5)$$

The requirements described above also apply to trailers with more than two axles. Then, the adhesion utilization rates used by the front axle assembly and the rear axle assembly are calculated based on the relationship:

$$f_1 = \frac{\sum f_{1i} R_{1i}}{\sum R_{1i}} \quad f_2 = \frac{\sum f_{2i} R_{2i}}{\sum R_{2i}} \quad (6)$$

The wheel locking requirements may be considered fulfilled if; for braking efficiency rates between 0.15 and 0.30, the adhesion utilized by at least one of the front axles is greater than that applied by at least one of the rear axles [2]:

$$f_{1i} > f_{2i} \quad \text{for any } i \quad (7)$$

In the considerations regarding the distribution of brake forces (2)-(5), each part of a road unit is treated as a single vehicle, without taking into account the braking control of towed vehicles. Hence, in order to ensure the compatibility of brake forces in a vehicle combination, acceptable bands of changes of braking ratios of individual vehicles for their characteristic load states in a control pressure function on the coupling head [2] have been determined - Fig. 2.

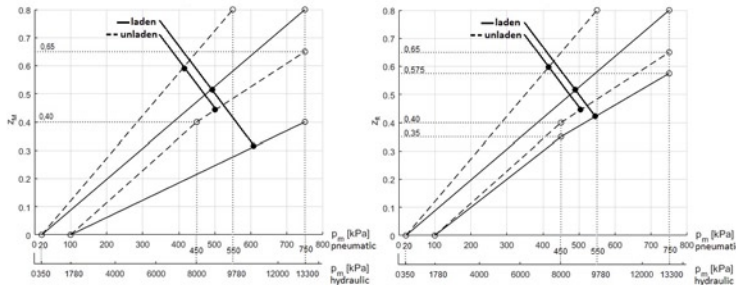

Fig. 2. Permissible bands of braking rate for tractors  $z_M$  and trailers  $z_R$  in a pressure function  $p_m$  in a control line

### 3. The determination of the permissible distribution area of brake forces in two-axle trailers

As shown in Figure 3, dynamic normal force on front and rear axles of a trailer on the horizontal road surface varies depending on the braking intensity (braking efficiency rate  $z$ ) as follows:

$$R_1 = \frac{G}{L}(b + h \cdot z) \quad R_2 = \frac{G}{L}(L - b - h \cdot z) \quad (8)$$

where:  $L$  – wheelbase of a trailer,  $h$  - height of the center of gravity,  $b$  – horizontal distance between center of gravity and rear axle.

The relative (relating to the  $G$  weight of a trailer) of braking force of the front axle  $\gamma_1$  and rear  $\gamma_2$  is calculated based on the relationship:

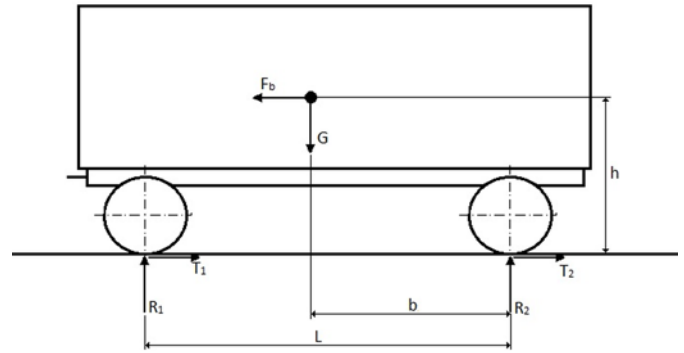

Fig. 3. Diagram showing forces acting upon a two-axle trailer during braking.

$$\gamma_1 = \frac{T_1}{G} = \frac{R_1 f_1}{G} = \left( \frac{b}{L} + \frac{h}{L} z \right) f_1 \quad \gamma_2 = \frac{T_2}{G} = \frac{R_2 f_2}{G} = \left( 1 - \frac{b}{L} - \frac{h}{L} z \right) f_2 \quad (9)$$

where:  $T_1, T_2$  - braking forces of the front and rear axles,  $R_1, R_2$  - normal reactions of the road surface on the wheels of  $i$ -th axle:

Under ideal braking conditions, the adhesion utilization ratios used by the front and rear axle of a trailer are indistinguishable and equal to the braking intensity  $f_1=f_2=z$ , and the distribution of brake forces is described by the parametric equation:

$$\gamma_1 = \left( \frac{b}{L} + \frac{h}{L} z \right) z \quad \gamma_2 = \left( 1 - \frac{b}{L} - \frac{h}{L} z \right) z \quad (10)$$

Using the dependences on the limit values of the adhesion rates used by the axles (2,3,4,5) along with the technical data of a trailer, it is possible to determine the lower and upper limit of the permissible distribution of brake forces in the diagram of relative of brake forces  $\gamma_2=f(\gamma_1)$ . Graphic interpretation of the described recommendations according to the first solution is illustrated by lines AB and CD in Fig.4-a and Fig.5-a. The corresponding limitations of the brake forces in the coordinate system  $\gamma_1$ - $\gamma_2$  for an unladen trailer when unladen and when laden are shown in Fig.4-b and Fig.5-b. The margin curves are calculated by substituting the adhesion utilization rates  $f_1, f_2$  determined from the conditions (2), (3) to the relation (9).

In the second solution, the limitations of the acceptable area of adhesion utilization rates are marked by lines MN and JKL in Fig.4-c and Fig.5-c. The corresponding areas of relative brake forces according to the second solution are shown in Fig. 4-d for an unladen trailer, and for a laden trailer in Fig.5-d. Due to the restrictive nature of the condition (4) for the upper margin K'L' on the chart  $\gamma_2=f(\gamma_1)$ , its scope was limited to the range of  $z=0.3 \div 0.61$ .

The equations of individual lines and margin curves in the  $f_{1,2}$ - $z$  and  $\gamma_1$ - $\gamma_2$  systems along with the coordinates of individual points are summarized in Tab.2 and Tab.3.

### 4. The selection of linear distribution of brake forces in two-axle trailers

In air braking systems of agricultural trailers, braking force correctors with radial (linear) characteristics are usually used [8, 17, 28]. This characteristic is described by the equation of a straight line passing through the beginning of the coordinate system and a second selected point on the graph of relative of brake forces  $\gamma_2=f(\gamma_1)$  taking into account the area limitations described in the previous chapter. The procedure for determining the acceptable range of changes in the

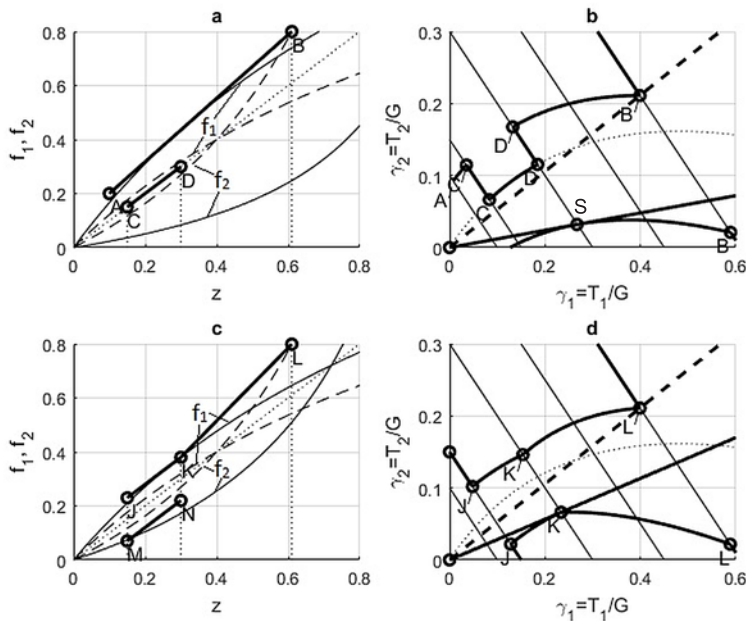

Fig. 4. Determining the parameters of constant distribution of brake forces for an unladen trailer weighing 4200 kg: a, c - runs of adhesion utilization rates used by axles  $f_1, f_2$ ; b - boundary values of the distribution coefficient according to solution 1; d - boundary values of the distribution coefficient according to solution 2;  $L = 2.95$  m;  $b = 1.47$  m;  $h = 1.15$  m

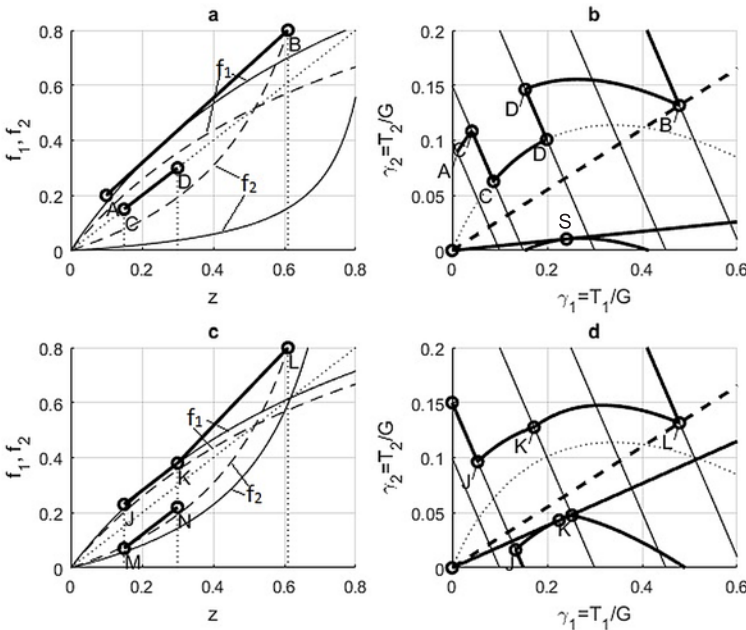

Fig. 5. Determining the parameters of constant distribution of brake forces for a loaded trailer with a mass of 16250 kg: a, c - runs of adhesion utilization ratios used by axles  $f_1, f_2$ ; b - limit values of the separation factor according to solution 1; d - limit values of the separation factor according to solution 2;  $L = 2.95$  m;  $b = 1.47$  m;  $h = 1.63$  m

directional coefficient  $i_p = T_2/T_1 = \gamma_2/\gamma_1$  of straight lines showing a constant distribution of brake forces should be carried out for laden and unladen vehicles.

In the first solution, the area of permissible linear distribution of brake forces is determined from the bottom; by a straight line OS tangent to the margin curve AB at point S (Fig.4-b, Fig.5-b), and from the

top; by a straight line passing through point D or B' (select a straight line with a smaller value of a directional coefficient).

When using the second solution, the lower margin of the acceptable area is determined by a straight tangent line at the point T with the JK curve (Fig. 4-d). If the point of contact T lies outside the JK section of the margin curve then the direction coefficient of the margin line is determined on the basis of the coordinates of point K (Fig.5-d). The upper margin of the linear distribution of brake forces is determined by the straight line passing through point L' (Fig. 4-d, Fig. 5-d). Sometimes it can also be point N.

Since the straight line of the linear distribution of brake forces passes through the beginning of the coordinate system  $\gamma_2 = f(\gamma_1)$ , its direction coefficient is calculated in each case from the ratio of the ordinate to the abscissa of the given characteristic point P:

$$i_p = \frac{\gamma_{2p}}{\gamma_{1p}} = \frac{1 - b/L - z_p \cdot h/L}{b/L + z_p \cdot h/L} \quad (11)$$

Where: P - symbol of a characteristic point.

Using the dependence  $z = \gamma_1 + \gamma_2$ , it is possible to describe the distribution of brake forces of individual axles for a given line by means of a parametric equation:

$$T_1 = \frac{1}{1 + i_p} G \cdot z \quad T_2 = \frac{i_p}{1 + i_p} G \cdot z \quad (12)$$

in which the parameter is the braking rate z. The adhesion utilized rates by the axles on a given distribution line of braking force are calculated as follows:

$$f_1 = \frac{T_1}{R_1} = \frac{z}{\left(\frac{b}{L} + z \frac{h}{L}\right)(1 + i_p)} \quad f_2 = \frac{T_2}{R_2} = \frac{i_p \cdot z}{\left(1 - \frac{b}{L} - z \frac{h}{L}\right)(1 + i_p)} \quad (13)$$

The results of the calculation of the limit values of directional coefficients  $i_p$  for the considered two-axle trailer are summarized in Table 4.

The courses of coefficients  $f_1, f_2$  of adhesion utilized by the axles, corresponding to the individual margin lines of the distribution of brake forces (tab. 4), calculated for dependence (13) for the 1st and 2nd solution, are shown in Fig. 4,5-a, c.

When choosing the range of changes of the real distribution of brake forces  $i = T_2/T_1$  for an unladen and a laden trailer, one should strive to approximate with the upper straight margin line. This ensures a short braking distance with the simultaneous danger of the earlier locking of rear wheels in an intensity range greater than the braking rate at the intersection of the ideal distribution curve (10) with a constant distribution line.

The coefficient of adhesion utilization (the factor of using the vehicle's weight for braking) is a measure of the efficiency of a well-chosen distribution of brake forces of the vehicle for different values of  $\mu$ :

$$\zeta(\mu) = \frac{T}{\mu \cdot G} = \frac{z}{\mu} \quad (14)$$

where:  $\mu$  - coefficient of adhesion

In the search for an optimal value of a linear coefficient of a braking force distribution, the criterion of equality of minimum coefficient

Table 2. The requirements of braking efficiency and stability for trailers

Curve	Coordinate system $f_{1,2}z$	Coordinate system $\gamma_1-\gamma_2$	Range
A-B	$z \geq 0.85 \cdot f_{1,2} - 0.07$	$\gamma_1 = \left(\frac{b}{L} + \frac{h}{L}z\right)\left(\frac{z+0.07}{0.85}\right)$	$z=0.1-0.61$
C-D	$z \leq f_{1,2}$	$\gamma_1 = \left(\frac{b}{L} + \frac{h}{L}z\right)z$	$z=0.15-0.30$
A'-C' D'-B'	$z \geq 0.85 \cdot f_{1,2} - 0.07$	$\gamma_1 = z - \left(1 - \frac{b}{L} - \frac{h}{L}z\right)\left(\frac{z+0.07}{0.85}\right)$	$z=0.1-0.15$ $z=0.3-0.61$
J-K	$z \leq f_{1,2} - 0.08$	$\gamma_1 = \min \begin{cases} \left(\frac{b}{L} + \frac{h}{L}z\right)(z+0.08) \\ z - \left(1 - \frac{b}{L} - \frac{h}{L}z\right)(z-0.08) \end{cases}$	$z=0.15-0.30$
M-N	$z \leq f_{1,2} + 0.08$	$\gamma_1 = \max \begin{cases} \left(\frac{b}{L} + \frac{h}{L}z\right)(z-0.08) \\ z - \left(1 - \frac{b}{L} - \frac{h}{L}z\right)(z+0.08) \end{cases}$	$z=0.15-0.30$
K-L	$z \geq 0.3 + 0.74(f_{1,2} - 0.38)$	$\gamma_1 = \left(\frac{b}{L} + \frac{h}{L}z\right)\left(\frac{z-0.3}{0.74} + 0.38\right)$	$z=0.30-0.61$
K'-L'	$z \geq 0.3 + 0.74(f_{1,2} - 0.38)$	$\gamma_1 = z - \left(1 - \frac{b}{L} - \frac{h}{L}z\right)\left(\frac{z-0.3}{0.74} + 0.38\right)$	$z=0.30-0.61$

Table 3. The coordinates of characteristic points; there is a dependency of  $\gamma_2 = z - \gamma_1$  for all ranges.

Point	z	$f_{1,2}$	$\gamma_1$
A	0.10	0.20	$0.2(b/L + 0.1 \cdot h/L)$
B	0.61	0.80	$0.8(b/L + 0.61 \cdot h/L)$
C	0.15	0.15	$0.15(b/L + 0.15 \cdot h/L)$
D	0.30	0.30	$0.3(b/L + 0.3 \cdot h/L)$
A'	0.10	0.20	$0.1 - 0.2(1 - b/L - 0.1 \cdot h/L)$
C'	0.15	0.259	$0.15 - (0.22/0.85)(1 - b/L - 0.15 \cdot h/L)$
D'	0.30	0.435	$0.3 - (0.37/0.85)(1 - b/L - 0.3 \cdot h/L)$
B'	0.61	0.8	$0.61 - (0.68/0.85)(1 - b/L - 0.61 \cdot h/L)$
J	0.15	0.23	$\min \begin{cases} 0.23(b/L + 0.15 \cdot h/L) \\ 0.15 - 0.07(1 - b/L - 0.15 \cdot h/L) \end{cases}$
K	0.30	0.38	$\min \begin{cases} 0.38(b/L + 0.3 \cdot h/L) \\ 0.3 - 0.22(1 - b/L - 0.3 \cdot h/L) \end{cases}$
L	0.61	0.8	$(b/L + 0.61 \cdot h/L)(0.31/0.74 + 0.38)$
M	0.15	0.07	$\max \begin{cases} 0.07(b/L + 0.15 \cdot h/L) \\ 0.15 - 0.23(1 - b/L - 0.15 \cdot h/L) \end{cases}$
N	0.30	0.22	$\min \begin{cases} 0.22(b/L + 0.3 \cdot h/L) \\ 0.3 - 0.38(1 - b/L - 0.3 \cdot h/L) \end{cases}$
K'	0.30	0.38	$0.38(1 - b/L - 0.3 \cdot h/L)$
L'	0.61	0.8	$0.61 - (1 - b/L - 0.61 \cdot h/L)(0.31/0.74 + 0.38)$

Table 4. Limit values of directional coefficients for a linear distribution of brake forces for a two-axle trailer

Variant of the solution	An unladen trailer	A laden trailer
The first solution acc.to (2), (3)	$i_{\min}=i_S=0.1202$	$i_{\min}=i_S=0.0434$
	$i_{\max}=i_B=0.5293$	$i_{\max}=i_B=0.2754$
The second solution acc.to (4), (5)	$i_{\min}=i_K=0.2832$	$i_{\min}=i_T=0.1914$
	$i_{\max}=i_L=0.5383$	$i_{\max}=i_L=0.2750$
Optimal coefficient acc.to (16)	$i_{opt}=0.5759$	$i_{opt}=0.4463$

of adhesion utilization for two extreme values of adhesion coefficients  $\mu_1 < \mu < \mu_2$  [6] characterizing the vehicle operation conditions is used:

$$\zeta(\mu_1) = \zeta(\mu_2) \quad (15)$$

or the criterion of maximizing the average adhesion utilization coefficient  $\zeta(\mu)$  in a given range  $(\mu_1, \mu_2)$  [7]:

$$\zeta_{sr} = \frac{1}{\mu_2 - \mu_1} \int_{\mu_1}^{\mu_2} \zeta(\mu) d\mu \quad (16)$$

In the case of two-axle trailers, the same optimal value of the coefficient of adhesion is obtained for both criteria [10]:

$$\mu_{op} = \mu_1 + \frac{b}{L}(\mu_2 - \mu_1) \quad (17)$$

On this basis, it is easy to determine the optimal value of the directional coefficient for the distribution of brake forces [9, 10]:

$$i_{opt} = \frac{1 - b/L - \mu_{op} \cdot h/L}{b/L + \mu_{op} \cdot h/L} \quad (18)$$

by changing  $b/L$  and  $h/L$  values respectively for an unladen and a laden trailer. In calculations for agricultural trailers, one can take  $\mu_1=0.2$  and  $\mu_2=0.5$  [9]. The optimal line of constant distribution of brake forces calculated from the formula (18) must lie within the permissible range defined by simple margin lines (Tab.4). In the case under consideration here, the optimum values of the directional coefficient for an unladen and a laden trailer are greater than the maximum permissible value. Nevertheless, this fact supports the adoption of higher values of braking distribution coefficients, close to the optimal values (the second solution).

If the lines of distribution of relative of brake forces pass through point B' (the first solution) or L' (the second solution), the distribution coefficients are identical. In both cases, the curve  $f_2(z)$  of adhesion utilized by the rear axle passes through the point of coordinates  $z=0.61$  and  $f_2(0.61)=0.8$ . Calculating the brake forces for this point:

$$\begin{aligned} T_2 &= f_2 R_2 = 0.8G \left( 1 - \frac{b}{L} - 0.61 \frac{h}{L} \right) \\ T_1 &= G \cdot z - T_2 = G \left[ 0.61 - 0.8 \left( 1 - \frac{b}{L} - 0.61 \frac{h}{L} \right) \right] \end{aligned} \quad (19)$$

the following statement is given for the factor of distribution of brake forces:

$$i_P = \frac{T_2}{T_1} = \frac{0.8(1 - b/L - 0.61h/L)}{0.61 - 0.8(1 - b/L - 0.61h/L)} \quad (20)$$

The differences between maximum values  $i_{max}$  given in Tab. 4 for both solutions result from rounding of inequality coefficients (5). For precise calculations, the divisor in the statement (5) should be 0.7381.

### 5. The selection of linear distribution of brake forces in three-axle trailers

In agricultural three-axle trailers, two rear axles are located close and work in a tandem arrangement. The braking force on the rear axle assembly must be distributed according to the load distribution between the tandem suspension axles. The system of forces acting on an agricultural three-axle trailer with tandem suspension of 'walking beam' type is shown in Fig.6. In the adopted calculation model, it is assumed that the un-sprung weight of the tandem axles will be omitted, which means that the forces of gravity and the inertia of the suspension are omitted.

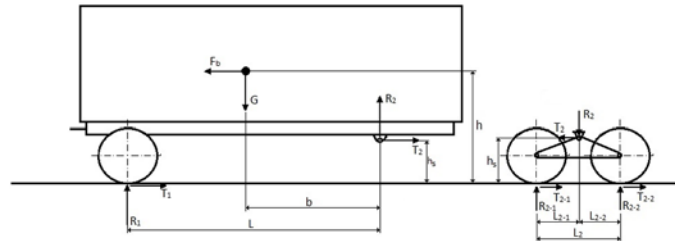

Fig. 6. Scheme of forces acting on a three-axle trailer with a 'walking beam' tandem suspension

The balance of forces and moments acting on the trailer takes the form:

$$\sum F_x = T_1 + T_2 - G \cdot z = 0 \quad (21)$$

$$\sum F_y = R_1 + R_2 - G = 0 \quad (22)$$

$$\sum M_2 = G \cdot b + G \cdot z(h - h_s) + T_1 \cdot h_s - R_1 \cdot L = 0 \quad (23)$$

After solving the above system of equations, the relationships describing reactions  $R_1$  and  $R_2$  acting on the trailer are obtained:

$$R_1 = G \left( \frac{b}{L} + z \frac{h - h_s}{L} \right) + T_1 \frac{h_s}{L} \quad \text{or} \quad R_1 = G \left( \frac{b}{L} + z \frac{h}{L} \right) - T_2 \frac{h_s}{L} \quad (24)$$

$$R_2 = G \left( 1 - \frac{b}{L} - z \frac{h - h_s}{L} \right) - T_1 \frac{h_s}{L} \quad \text{or} \quad R_2 = G \left( 1 - \frac{b}{L} - z \frac{h}{L} \right) + T_2 \frac{h_s}{L} \quad (25)$$

where:

$$T_1 = \frac{1}{1 + i_P} G \cdot z \quad T_2 = G \cdot z - T_1 \quad (26)$$

The balance of forces and moments acting on the tandem suspension takes the form:

$$\sum F_x = T_{21} + T_{22} - T_2 = 0 \quad (27)$$

$$\sum F_y = R_{21} + R_{22} - R_2 = 0 \quad (28)$$

$$\sum M_{21} = T_2 \cdot h_s + R_{22}L_2 - R_2 \cdot L_{21} = 0 \quad (29)$$

In order to determine the distribution of the braking force T2 between the wheels of the tandem axle unit, a linear distribution of brake forces is assumed:

$$\frac{T_{22}}{T_{21}} = i_S$$

By solving a system of equations (27)-(29), we obtain the value of forces acting on wheels in tandem axles during braking:

$$R_{21} = R_2 \frac{L_{22}}{L_2} + T_2 \frac{h_s}{L_2} \quad R_{22} = R_2 \frac{L_{21}}{L_2} - T_2 \frac{h_s}{L_2} \quad (31)$$

$$T_{21} = \frac{T_2}{1+i_S} \quad T_{22} = \frac{i_S}{1+i_S} T_2 \quad (32)$$

Formulas (24), (25) and (31), (32) can also be used for a ‘boogie’ tandem suspension.

The Monte Carlo method [3], [18], [20] was used to search for an acceptable range of variability of  $i_p$  and  $i_s$  coefficients of distribution of brake forces in order to find optimal solutions. A block diagram of an algorithm for an optimal selection of the braking force distribution coefficients is shown in Fig.7. On its basis, a computer program was developed in the Matlab [25] environment.

The optimum values of the braking force distribution coefficients were determined in the process of minimizing the objective function in the form of:

$$FC = \frac{w_1 (f_1 - f_2)^2 + w_2 (f_{21} - f_{22})^2}{w_1 + w_2} \quad (33)$$

where:  $w_i$  - weighting factors.

The function formulated this way prefers the solutions that approximate the adhesion utilized  $f_i$  by individual axles.

Before calculating the objective function, we have checked the inequality constraints (4), (5) for the second solution:

$$\begin{aligned} f_1 &\geq f_1^{down} = z - 0.08 \quad \text{for } z = 0.15 \div 0.30 \\ f_1 &\leq f_1^{up} = z + 0.08 \\ f_2 &\leq f_2^{up} = (z + 0.08)(0.15 \leq z \leq 0.30) + \left(\frac{z - 0.3}{0.7381} + 0.38\right)(z \geq 0.30) \end{aligned} \quad (34)$$

and condition (7):

$$f_1 > f_{21} \quad \text{or} \quad f_1 > f_{22} \quad \text{for } z = 0.15 \div 0.30 \quad (35)$$

In addition, an extra condition has been adopted for the adhesion utilized rates of rear axle:

$$f_{2i} \leq f_2^{up} \quad (36)$$

limiting excessive increase of coefficient  $f_{22}$  for  $z \leq 0.61$ .

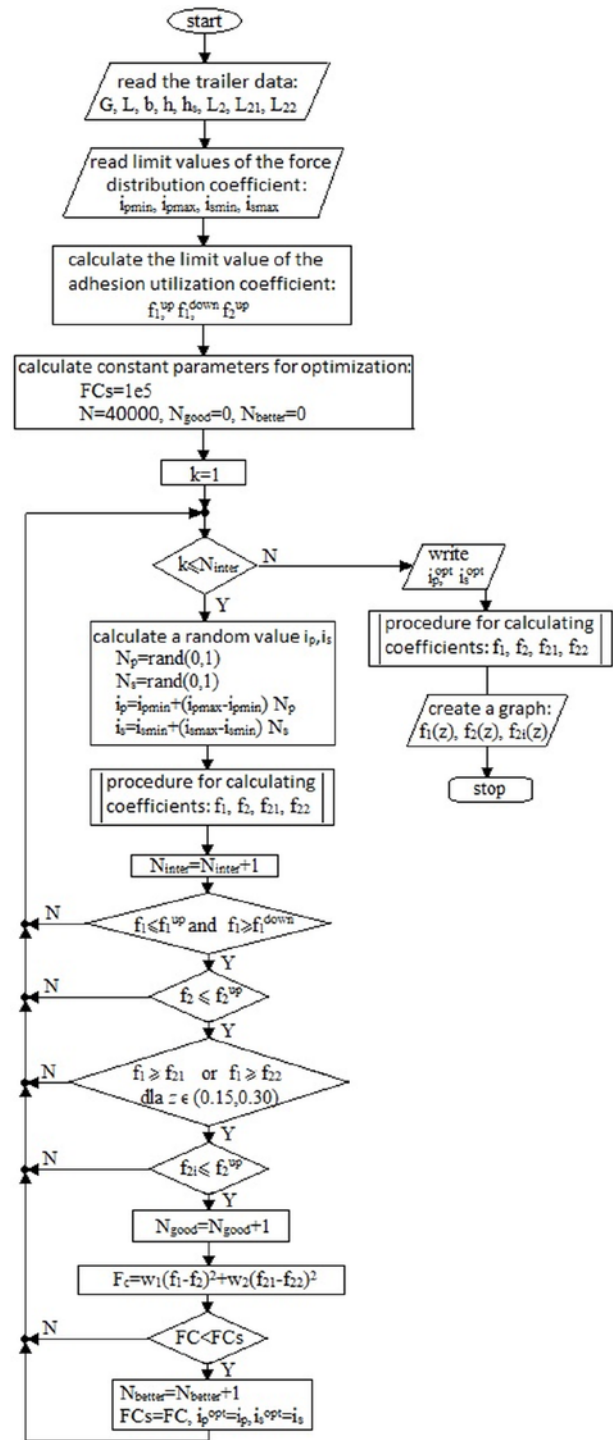

Fig. 7. A block diagram of an algorithm for the optimization of brake forces of a three-axle trailer using the Monte Carlo method ( $FC_s$  - initial value of the objective function,  $N$  - number of draws,  $N_{good}$  - a number of good solutions, meeting inequality constraints,  $N_{better}$  - number of better solutions, reducing the value of the objective function).

The results of the calculation of the distribution of braking force for an empty and a loaded trailer after several program start-ups are presented in Tab.5. The adopted number of draws was  $N = 40,000$ ,  $w_1=0.6$ ,  $w_2=0.4$ .

An example of the course of the adhesion utilization rates  $f_i(z)$  through the axles for an optimal distribution of brake forces for an unladen and a laden trailer is shown in Fig.8.

Table 5. The results of the optimization of distribution of brake forces in a three-axle trailer

No.	1	2	3	4	5	Average
An unladen trailer						
$i_s$	1.2971	1.2963	1.2944	1.2991	1.2955	1.2965
$i_p$	0.5150	0.5162	0.5155	0.5153	0.5157	0.5155
FC	1.7961	0.8805	0.4060	0.7386	1.5802	1.0803
A laden trailer						
$i_s$	0.9753	0.9737	0.9749	0.9729	0.9725	0.9739
$i_p$	0.5326	0.5337	0.5314	0.5333	0.5331	0.5328
FC	0.5287	0.5616	0.3032	1.1820	0.6626	0.6476

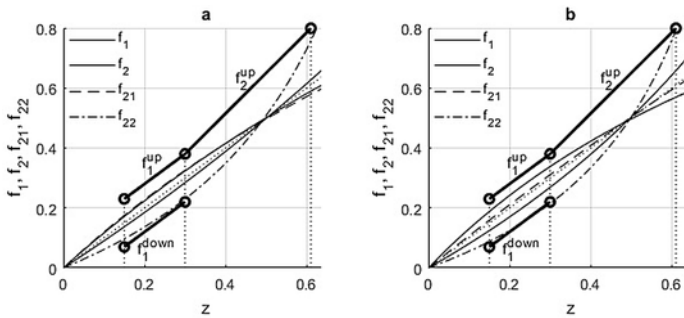

Fig. 8. The runs  $f_i(z)$  for an optimal distribution of brake forces: a - for an empty trailer ( $i_s = 1.2994$ ,  $i_p = 0.5155$ ,  $m = 7700\text{kg}$ ,  $L = 5.15\text{m}$ ,  $b = 1.85\text{m}$ ,  $h = 1.8\text{m}$ ,  $L2 = 1.345\text{m}$ ,  $L21 = 0.72\text{m}$ ,  $L22 = 0.62\text{m}$ ,  $h_s = 0.545\text{m}$ ), b - for a loaded trailer ( $i_s = 0.9749$ ,  $i_p = 0.5333$ ,  $m = 24000\text{kg}$ ,  $L = 5.15\text{m}$ ,  $b = 1.85\text{m}$ ,  $h = 1.8\text{m}$ ,  $L2 = 1.36\text{m}$ ,  $L21 = 0.73\text{m}$ ,  $L22 = 0.63\text{m}$ ,  $h_s = 0.514\text{m}$ )

**6. The calculations and selection of a brake mechanism and a starting mechanism**

Knowing the values of the brake forces of individual axles, the design parameters of their braking mechanisms and starting mechanisms can be calculated. Here you can use the following dependence on the braking force of  $i$ -th axle [2]:

$$T_i = k \cdot (C - C_0) \cdot \eta \cdot BF / r_d + f_r R_i \tag{37}$$

where:  $k$  – a number of actuators per axle,  $C$  - the torque on the cam shaft generated by the actuator,  $C_0$  – the threshold torque of the cam shaft necessary to create a measurable braking torque,  $\eta$  - mechanical efficiency,  $r_d$  - dynamic wheel radius,  $f_r$  – coefficients of the resistance of wheel rolling,  $R_i$  - load on the wheels of the  $i$ -th axle,  $BF$  - ‘Brake factor’ coefficient, is defined as follows [1]:

$$BF = \frac{C^* \cdot r_e}{2r_b} \tag{38}$$

where:  $C^*$  - coefficient of efficiency (internal brake ratio) of the brake mechanism [15],  $r_e$  – effective friction radius,  $r_b$  - effective radius of an S-cam.

The torque on the cam shaft is the product of the  $Th_a$  force generated by the pneumatic actuator acting on the lever span with length  $l$ :

$$C = Th_a l \tag{39}$$

Using the experimental data of the manufacturers of actuators, one may express the useful force on the piston rod by means of:

$$Th_a = A \cdot p - B \tag{40}$$

where:  $A$ ,  $B$  - experimental coefficients,  $p$  - pressure in the actuator chamber.

**7. Summary and conclusions**

The calculations described in this paper will enable the selection of an optimal linear distribution of brake forces in the design process of air braking systems on two- and three-axle agricultural trailers, in which the braking force correctors with radial characteristics are used. The calculations of the distribution of brake forces took into account the requirements of the EU Directive 2015/68 [2] in terms of braking efficiency and stability. The calculations of the distribution of brake forces form the basis of design calculations and enable, in the next stage of the design process, the selection of braking axle parameters (braking mechanism, actuator and applying device) and characteristics of brake valves.

The calculation of the distribution of brake forces made for a two-axle trailer with a capacity of about 16 tons, carried out for two possible variants of the distribution of brake forces, support the use of the second solution in the design calculations (according to requirements (4), (5)). The adhesion utilization rates calculated for this solution used by the axles are more similar to the straight line illustrating an ideal distribution of brake forces, in which the coefficients of adhesion utilized by each axle are the same and equal to the braking rate.

In the case of a two-axle trailer, the range of permissible changes of the linear coefficient of distribution of brake forces and its optimal value for various loading conditions are determined analytically, based on the graph of relative brake forces  $\gamma_2$  ( $\gamma_1$ ). However, in the case of three-axle trailers, in which the brake forces must be divided between the axles of the tandem assembly, faster results are obtained using optimization methods.

The developed algorithm looks for an optimal distribution of brake forces with the Monte Carlo method for trailers with ‘walking beam’ or ‘bogie’ type of rear axle suspensions, which can be easily adapted to the selection of brake forces distribution in trailers with other types of tandem axles by changing the block of procedure of calculation the adhesion utilized through axles (other dependencies on wheel reactions).

On the basis of the presented methodology, it is possible to develop rules for the distribution of brake forces of a trailer using braking force correctors with different characteristics than radial (linear) ones.



**Acknowledgement**

*Project financed with the program of the Minister of Science and Higher Education under the name "Regionalna Inicjatywa Doskonalosci" in the years 2019 - 2022 project number 011 / RID / 2018/19 amount of financing 12,000,000 PLN*



**Ministerstwo Nauki  
i Szkolnictwa Wyższego**

**References**

1. Andrew J D. Braking of Road Vehicles. Oxford: Butterworth-Heinemann, 2014.
2. Commission Delegated Regulation (EU) 2015/68 supplementing Regulation (EU) No 167/2013 of the European Parliament and of the Council with regard to vehicle braking requirements for the approval of agricultural and forestry vehicles, October 2014.
3. Dimov I T, Sean McKee S. Monte Carlo Methods for Applied Scientists. World Scientific Press, 2004.
4. Forrer P. Brake systems in agricultural and forestry vehicles, <http://www.paul-forrer.ch> (accessed 07 May 2019).
5. Glišović J, Lukić J, Vanja Šušteršič V, Čatić D. Development of tractors and trailers in accordance with the requirements of legal regulations. In: 9th International Quality Conference, Center for Quality, Faculty of Engineering, University of Kragujevac, June 2015, paper no. 3504: 193-201.
6. Gredeskul A B. O normativach effektivnosti tormoženiya avtomobilej. Avtomobilnaja promyšlennost 1963; 6: 14-16, <https://doi.org/10.1088/0031-9112/14/1/012>.
7. Gredeskul A B, Fedosov V M, Skutnev V M. Opredelenie parametrov tormoznoj sistemy s regulatorom tormoznyh sil. Avtomobilnaja promyšlennost 1975; 6: 24-26.
8. Haldex, Agricultural trailer product catalogue. Europe, Edition 1, 2015.
9. Kamiński Z. Distribution of braking forces in two-axle agricultural trailers. Teka Kom. Mot. Energ. Roln. 2005; 5: 80-86.
10. Kamiński Z, Miatluk M. Brake systems of road vehicles. Calculations. Białystok: Wydawnictwo Politechniki Białostockiej, 2005.
11. Kamiński Z. Simulation and experimental testing of the pneumatic brake systems of agricultural vehicles. Białystok: Oficyna Wydawnicza Politechniki Białostockiej, 2012.
12. Kamiński Z, Kulikowski K. Determination of the functional and service characteristics of the pneumatic system of an agricultural tractor with mechanical brakes using simulation methods. Eksploatacja i Niezawodność - Maintenance and Reliability 2015; 17(3): 355-364, <https://doi.org/10.17531/ein.2015.3.5>.
13. Kamiński Z. Mathematical modelling of the trailer brake control valve for simulation of the air brake system of farm tractors equipped with hydraulically actuated brakes. Eksploatacja i Niezawodność - Maintenance and Reliability 2014; 16(4): 637-643.
14. Keyser DE, Hogan K. Hydraulic brake systems and components for off-highway vehicles and equipment. National Fluid Power Association Technical Paper Series 1992; I 92-1.4: 1-9.
15. Keyser DE. Full power hydraulic brake actuation, circuit design considerations for off-highway vehicles and equipment. In: 10th International Conference on Fluid Power - the Future for Hydraulics, Brugge, Belgium, 5-7 April 1993, edited by N. Way. Mechanical Engineering Publications, London.
16. Khaled M, Mahmoud R. Theoretical and experimental investigations one new adaptive duo servo drum brake with high and constant brake shoe factor, university Paderborn, 2005.
17. Knorr-Bremse, Agricultural and forestry vehicles. Brake equipment catalogue, Y206317 - (EN - Rev. 001), 2015.
18. Kroese DP, Taimre T, Botev ZI. Handbook of Monte Carlo Methods. New York, 2011. <https://doi.org/10.1002/9781118014967>
19. Lin M, Zhang W. Dynamic simulation and experiment of a full power hydraulic braking system. Journal of University of Science and Technology Beijing 2007; 29(10): 70-75.
20. Morton DP, Popova E. Monte Carlo simulations for stochastic optimization: Encyclopedia of Optimization. In: Floudas CA, Pardalos PM (eds) Monte Carlo simulations for stochastic optimization. Kluwer Academic Publishers, 2001; 1529-1537, [https://doi.org/10.1007/0-306-48332-7\\_305](https://doi.org/10.1007/0-306-48332-7_305).
21. Radlinski RW, Flick MA. Tractor and trailer brake system compatibility. SAE Transactions; paper no. 861942, 1986, <https://doi.org/10.4271/861942>.
22. Safim. Trailer brake valve, [http://www.italgidravlika.ru/pdf\\_files/Safim/safim\\_11.pdf](http://www.italgidravlika.ru/pdf_files/Safim/safim_11.pdf) (accessed 15 May 2018).
23. Tang G, Zhao H, Wu J, Zhang Y. Optimization of Braking Force Distribution for Three-Axle Truck. SAE Technical Paper 2013-01-0414, 2013, <https://doi.org/10.4271/2013-01-0414>.
24. UN Economic Commission for Europe, ECE Regulation No. 13. Uniform provisions concerning the approval of vehicles of categories M, N and O with regard to braking, Geneva, Switzerland, 2001.
25. Venkataraman P. Applied Optimization with MATLAB Programming Wiley-Interscience. New York, 2001.
26. Wabco, FPB - Full Hydraulic Power Brake, Version 2/09, 2013.
27. Wabco, Off-highway. Overview technologies and products, Edition 2, Version 3, December 2016.
28. Wabco, Air braking system. Agriculture and forestry vehicles, Edition 11, Version 1, October 2017.

**Zbigniew KAMIŃSKI**

**Paweł RADZAJEWSKI**

Białystok University of Technology

Faculty of Mechanical Engineering

ul. Wiejska 45C, 15-351 Białystok, Poland

Emails: [radzajewskilech@wp.pl](mailto:radzajewskilech@wp.pl) [z.kaminski@pb.edu.pl](mailto:z.kaminski@pb.edu.pl)